

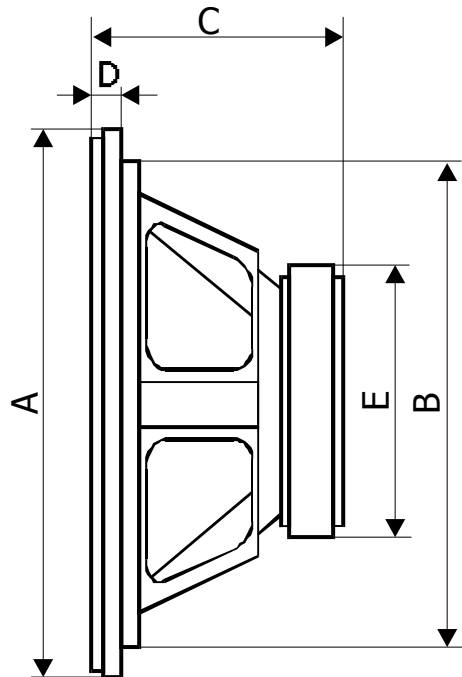

SPA 4050



A	Külső átmérő Diameter Durchmesser	385 mm
B	Beépítési átmérő Mounting cutout Einbauöffnung	352 mm
C	Beépítési mélység Mounting depth Einbautiefe	155 mm
D	Perem vastagság Edge width Randstreifen	10 mm
E	Mágnes átmérő Magnet diameter Magnetdurchmesser	155 mm